



GET READY FOR  
**LifeLike**  
experience

[www.3ds.com/ecforum](http://www.3ds.com/ecforum)

EUROPEAN CUSTOMER FORUM  
NOVEMBER 23-24, 2010-PARIS





# V6: Paradigm shift

Jean-Marie DURAND

# The promise is 3D for Lifelike Experience

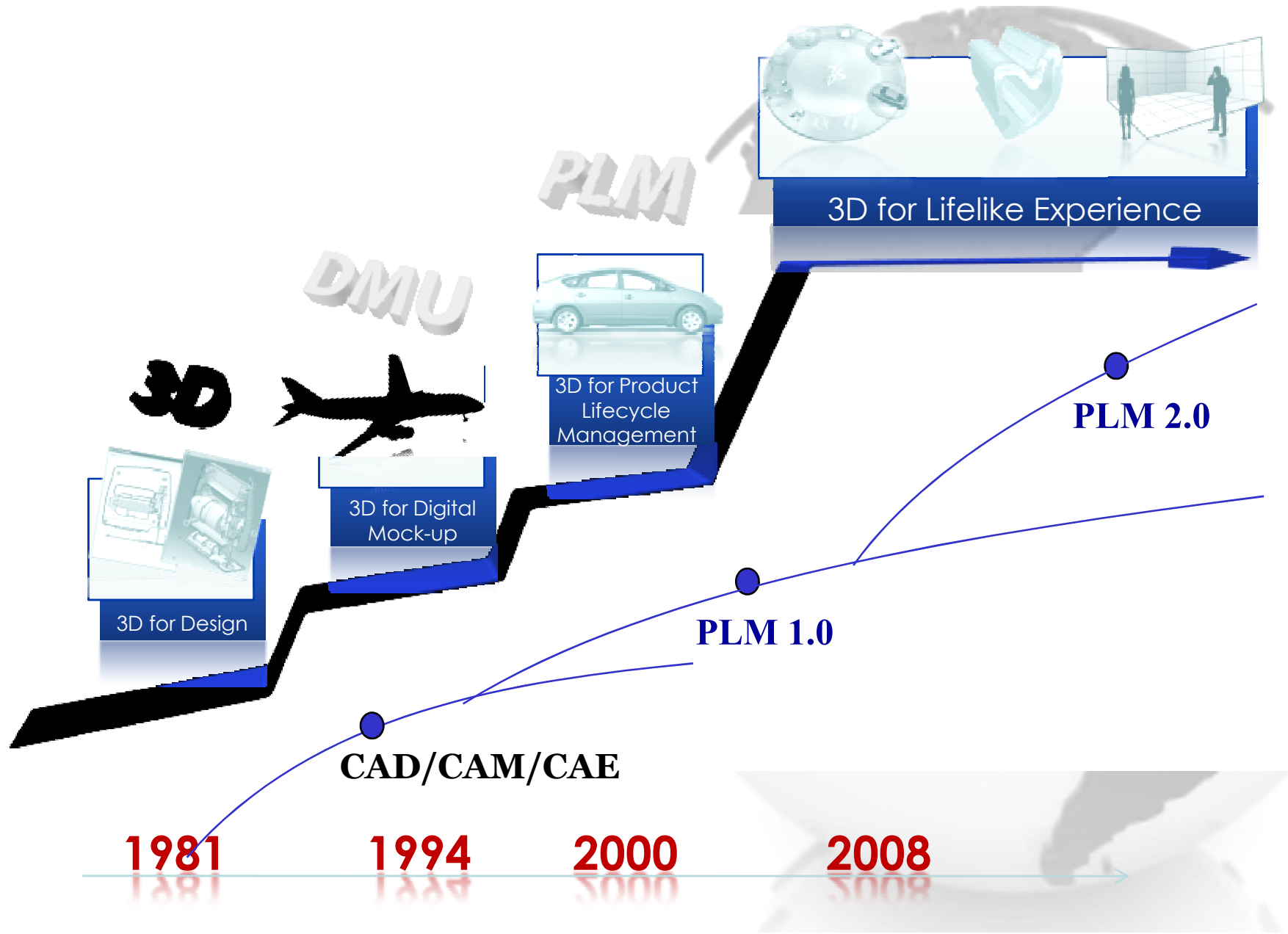

# V6: Paradigm Shift

- **Changing the rules with V6**
  - **End-to-End PLM**
    - From Voice of the customer to End-of-Life
  - **Collaboration**
    - Multi-disciplines, Mechatronics, Systems Engineering: SW ...
    - Engineering, Manufacturing, Support, Purchasing, Sales ....
  - **Extended Enterprise**
    - Design Anywhere, Manufacture Anywhere, Source Anywhere
    - Supplier collaboration, Program collaboration
  - **New Life like experience**
    - Extended 3D for all
- **A new relationship with our Customers**
  - Value based selling from Business Processes Analysis
  - Solution selling: SW, Services, Partnership...
  - C-Level Engagement for Enterprise Solution

# Dassault Systèmes V6 Organic Architecture

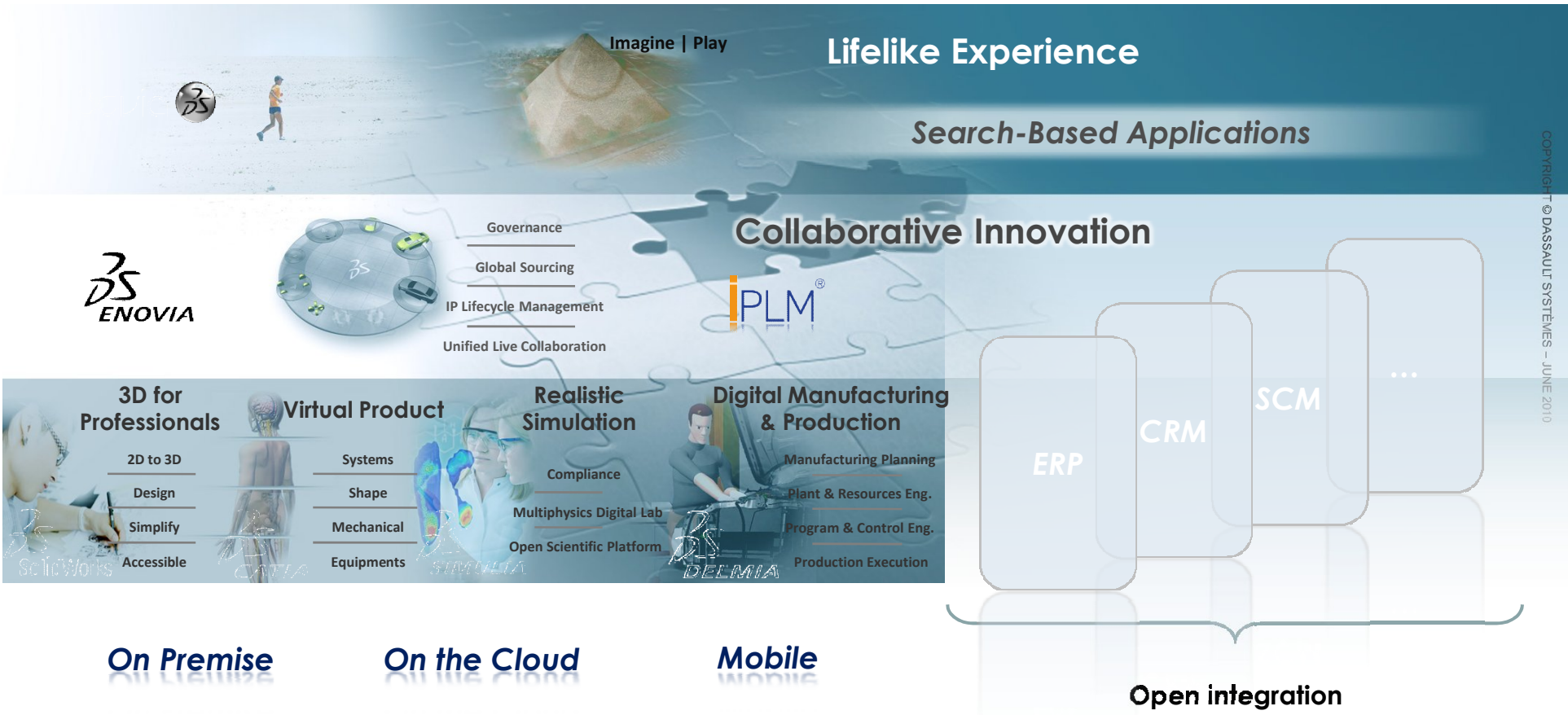

COPYRIGHT © DASSAULT SYSTEMES – JUIN 2010

**Extended Enterprise / B2B / Consumers**

[www.3ds.com/ecforum](http://www.3ds.com/ecforum)

**EUROPEAN CUSTOMER FORUM**  
NOVEMBER 23-24, 2010-PARIS





# V6 adoption in Aerospace & Defense

## Agusta Westland

World Wild Civil an Military Helicopter builder



### Global collaboration on V6 platform

*“A strong point influencing our decision was the greater efficiencies that a 3D world, powered by ENOVIA V6, can bring to our product development activities.”*

Gianmario Prato, Senior Vice President, ICT

# V6 adoption in the Automotive Industry

## Renault

Multi-brand car maker present in 118 countries



### Collaborative Design

*“We chose the full V6 portfolio because its integrated PLM environment perfectly responded to our requirements in terms of real-time collaboration and online-enabled design.”*

Odile Desforges, EVP Engineering and Quality

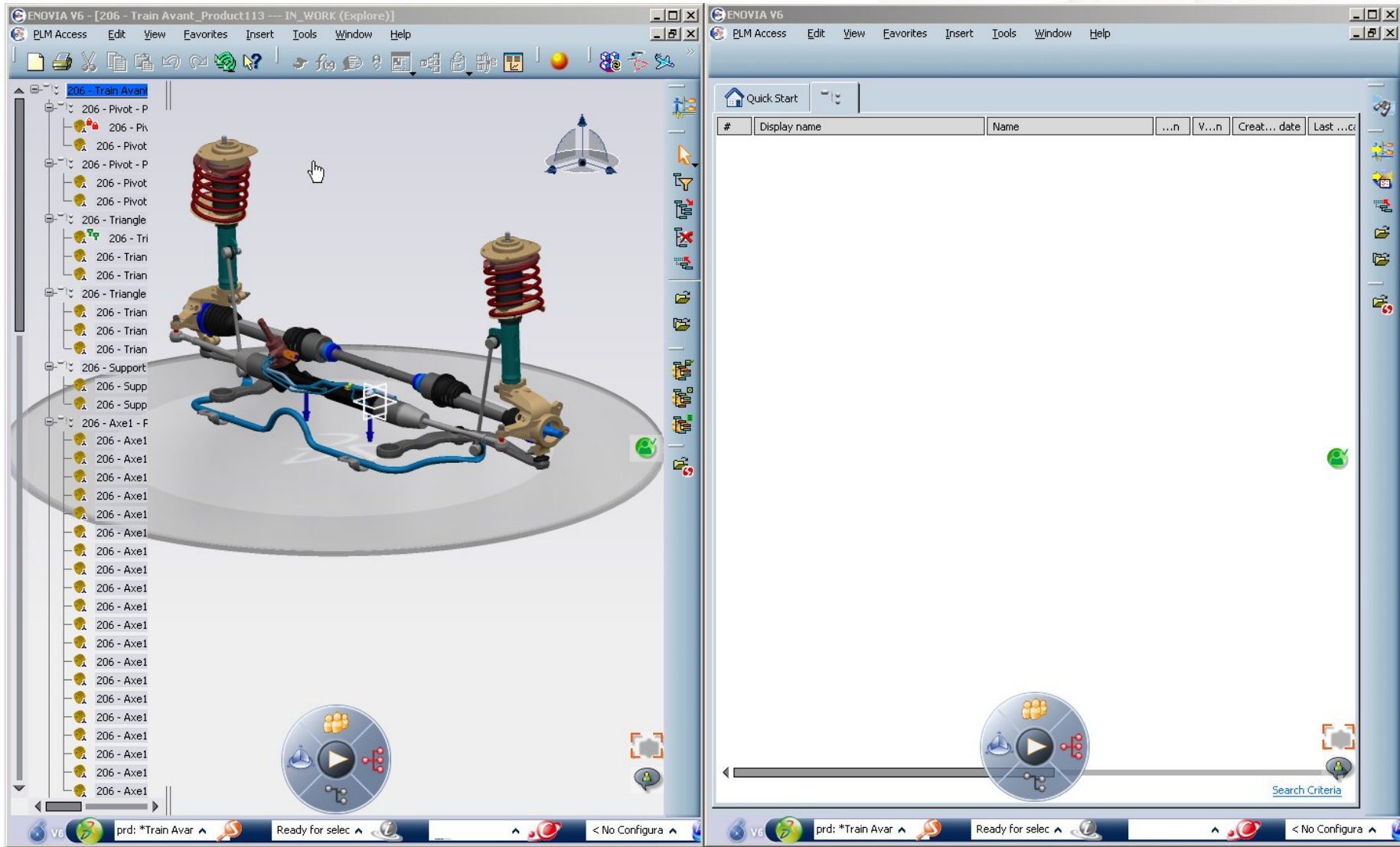



# V6 adoption in Automotive

## Automotive System Engineering Innovation

V6 for innovation in System Engineering domain



- “V6 System Engineering bring a unified environment to manage a real breakthrough for innovation: embedded software , electronics, mecatronics





# PLM Systems at the Heart of V6

## The World is Changing

Systems Everywhere

Smart  
Products



Smart  
Cities



Systems  
of Systems



*“Dassault Systemes is committed to help customers solve their most complex Systems Integration problems by delivering end to end solutions based on industry standards (Modelica, AUTOSAR, .....).”*

*« This journey represents for Dassault Systemes what 3D has represented for us in the past 30 years »*

# V6 adoption in Shipbuilding

## Meyer Werft

One of world's leading cruise shipbuilders, Germany

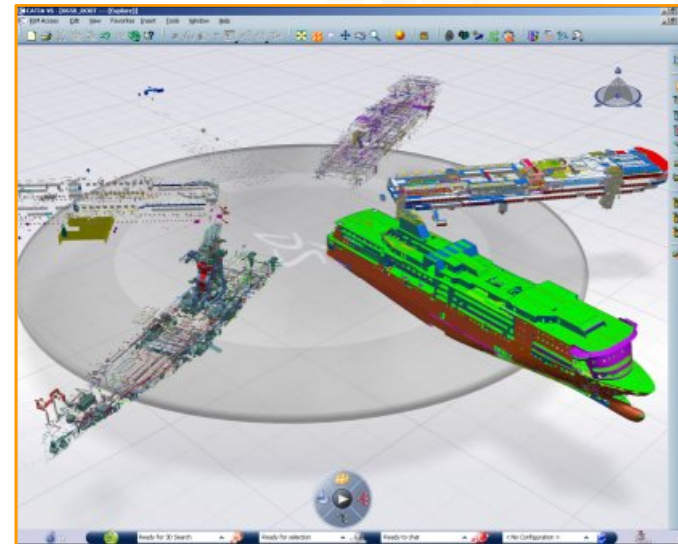

## Large Assembly Management

*“(V6) PLM is a key enabler for us allowing us to manage the increasing complexity of our ships in more effective ways.”*

Lambert Kruse, Managing Director



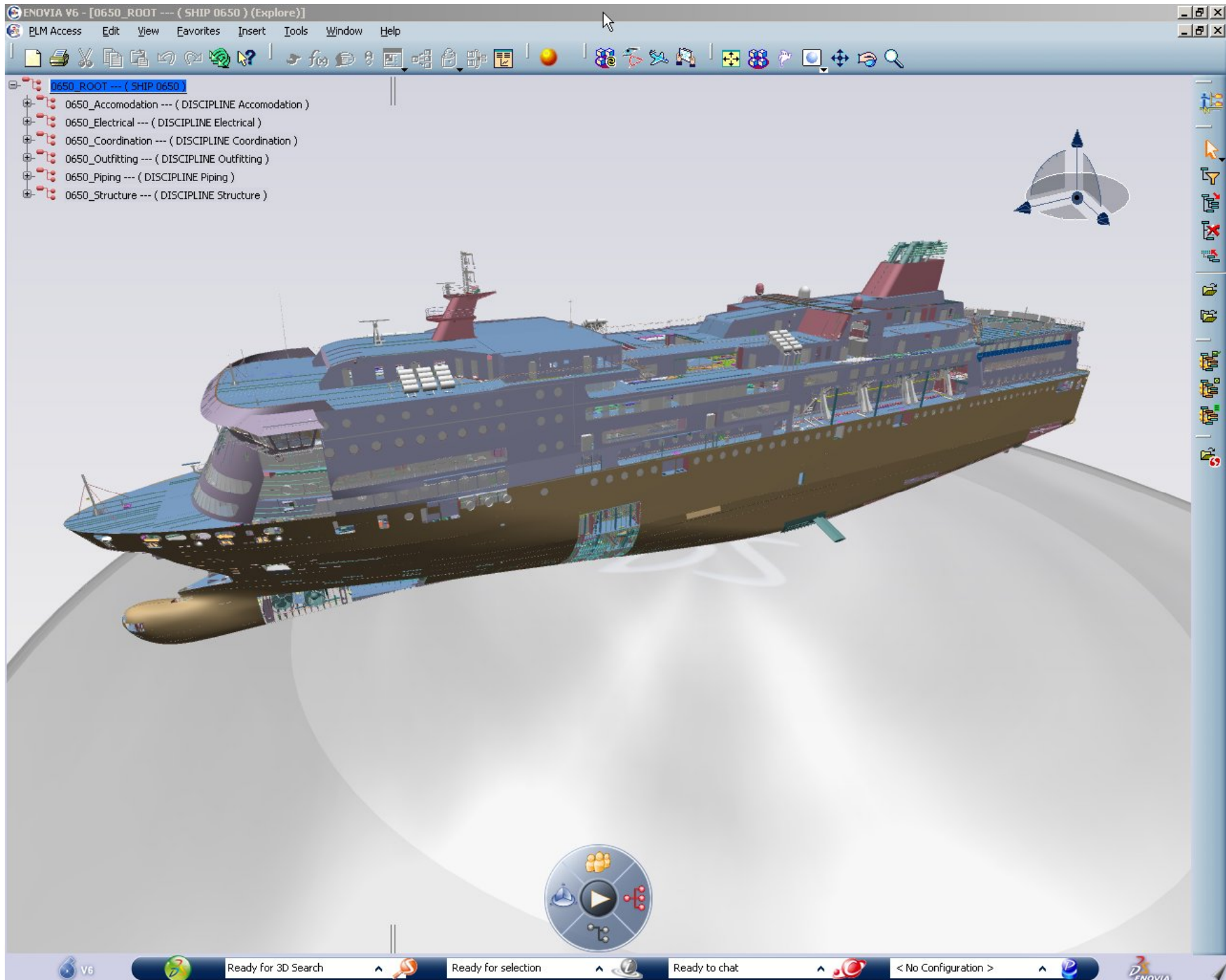

# V6 adoption in Energy Market

## Single version of truth and global collaboration

Plant Design, Asset management and operation ,Dismantle

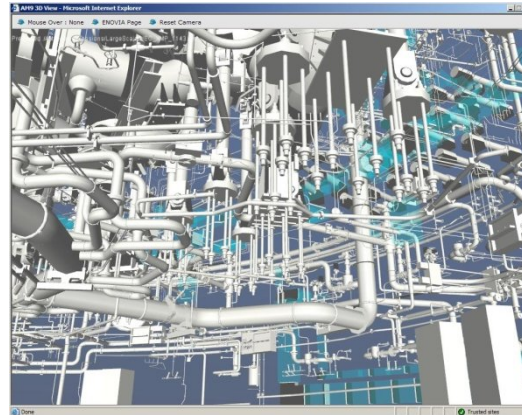
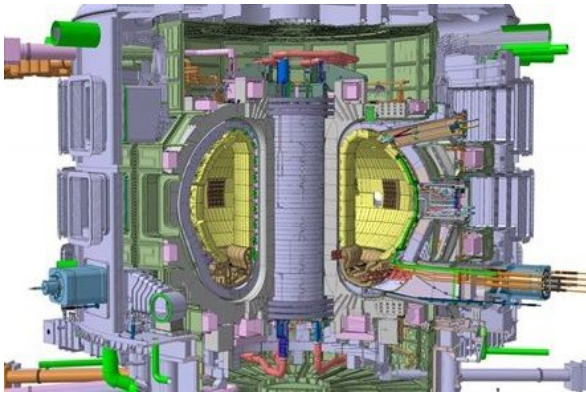

–“V6 Suite allows us to secure our configuration management and increase collaboration between our international Agencies”.

ENOVIA - Windows Internet Explorer

http://lufdsy:7585/ENG2010X/emxLogin.jsp

File Edit View Favorites Tools Help

ENOVIA

Home Stop Print Page Tools >>

Username:

Password:

Physical Country/Location:  
United States

Login

ENG2010X-V5  
July 2010

The ENERGY Demonstrator

**Security Acknowledgement**

This system is the property of this Corporation/organization, and is intended for the use of authorized users only. All activities of individuals using this computing system with or without authority, or in excess of their authority, may be monitored and recorded by system personnel. If any such monitoring reveals evidence of criminal activity or is in violation of foreign or U.S. state or federal law, such evidence may be provided to law enforcement officials and/or used for further legal action by this Corporation and/or the organization's Information Protection group. Unauthorized use of this system is prohibited and may result in revocation of access, disciplinary action and/or legal action. The company reserves the right to monitor and review user activity, files and electronic messages.

Reminder: Information transmitted to a foreign person on this network may be subject to applicable Export Control laws. Contact your Export Coordinator for assistance.

Done Local intranet 100%



# V6 adoption in Industrial Equipment

**Michelin**



Worldwide leading tire manufacturer, France

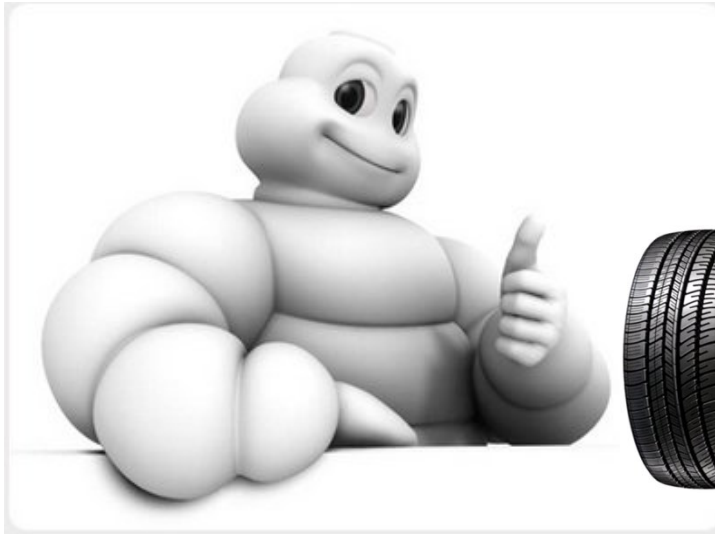

*“V6 Suite allows us to Optimize our Industrial Product Cost “CRI”, increase collaboration across domain (breaking silos) and optimize our Global Supply Chain”*



# Manufactured Product - MBOM

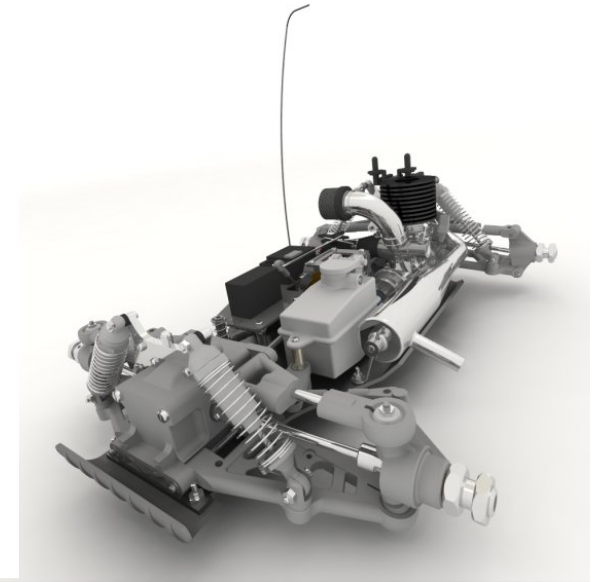
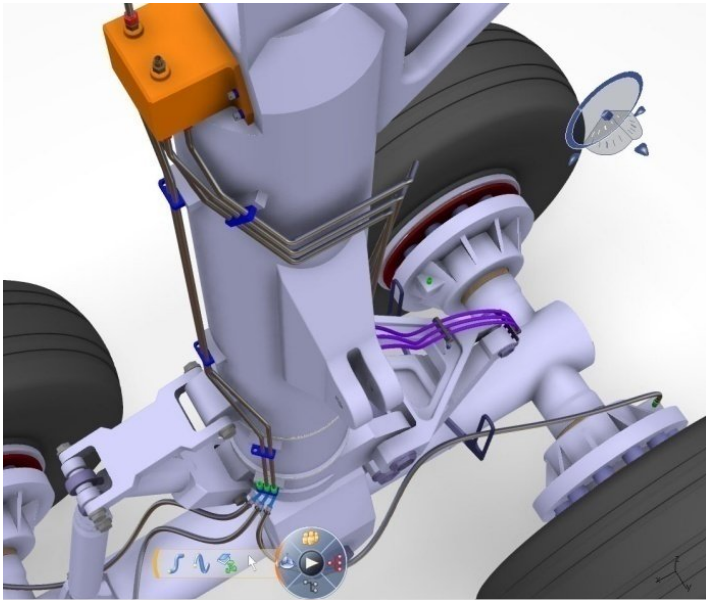

**“V6 is *Changing the game*”**

