



3DEXPERIENCE®

CATIA 3DEXPERIENCE

is more than what you think

Capital Market Day
June 10th 2016

Philippe LAUFER
CEO CATIA
@CATIABoss

Introducing CATIA LoveMark



- ▶ **A growing audience of loyal Users**

- ▶ Very high rate of maintenance renewal
- ▶ 1 650 New customers in 2015

- ▶ **Serving from 1 single man companies to WorldWide consortiums**

- ▶ Large Accounts / SMB* = 50-50 of New Licence Revenue & Recurring Users
- ▶ 8 000 companies with 1 or 2 Users

**Small & Medium Business*

Imagine & Shape the Connected World

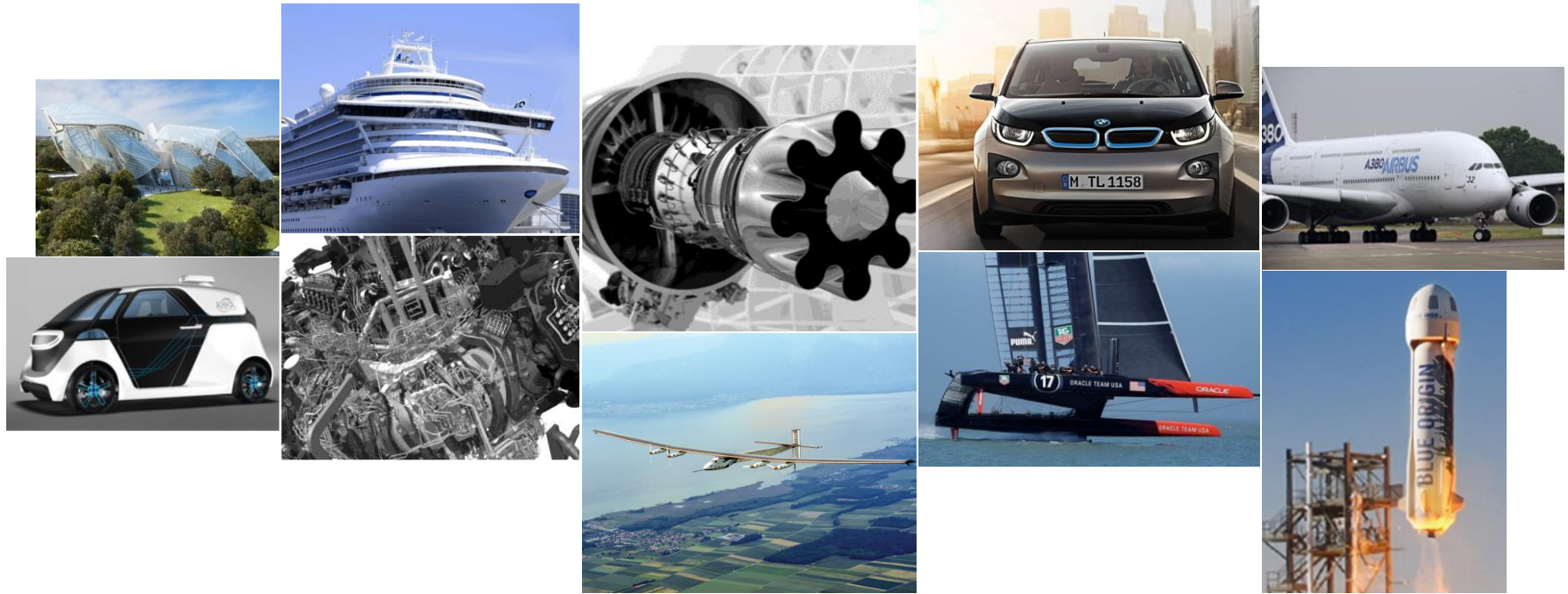

22 000 Customers in 77 countries since 1981

Growth Drivers for CATIA

DESIGN IN
THE AGE OF
EXPERIENCE

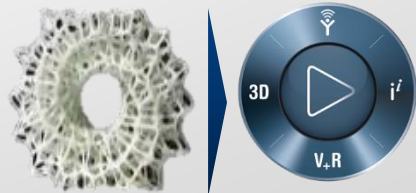

INDUSTRY
DIVERSIFICATION



INTERNET
OF
EXPERIENCE



SOCIAL
DESIGN

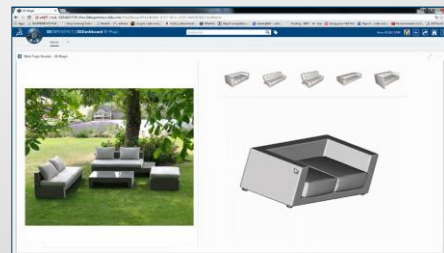

CATIA 3DEXPERIENCE

DESIGN IN
THE AGE OF
EXPERIENCE

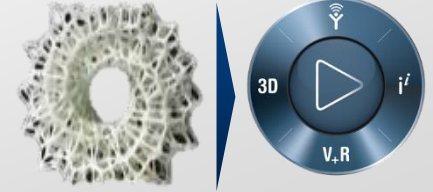



DESIGN | in the Age of Experience

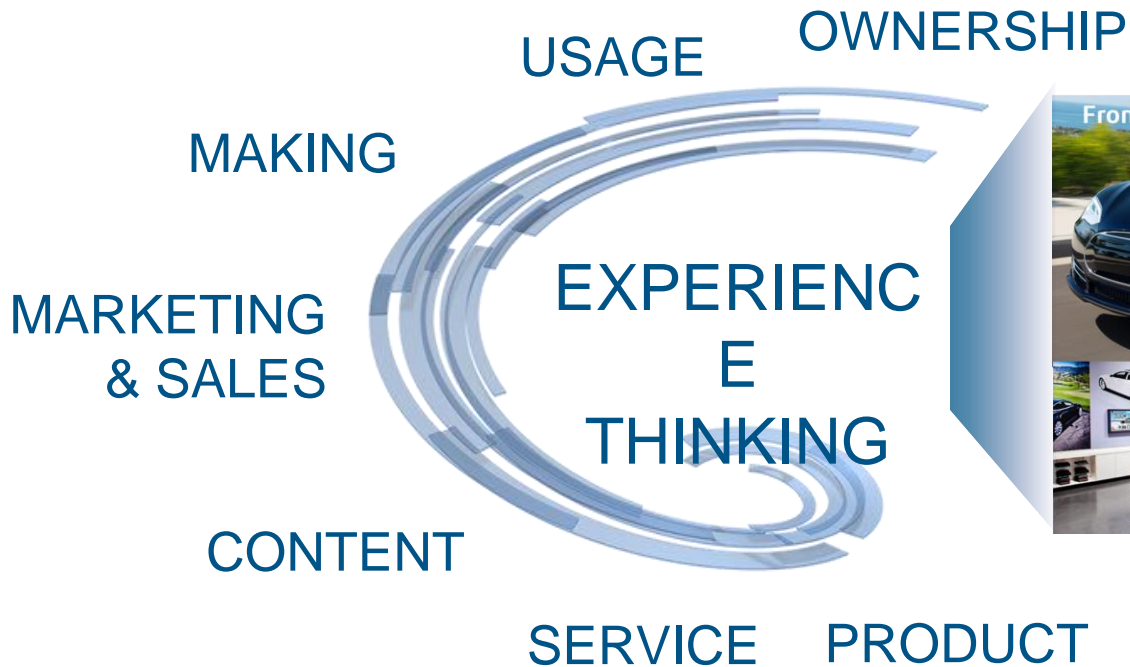

Design Synthesis

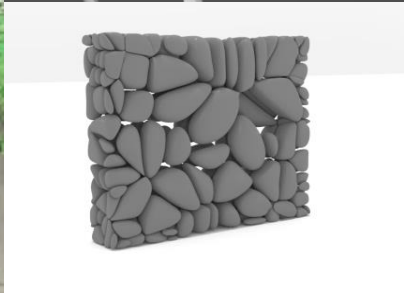
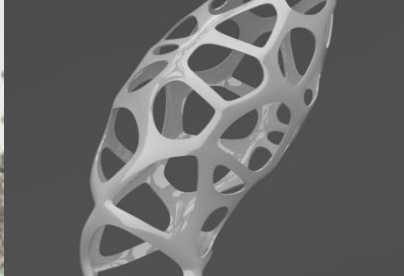
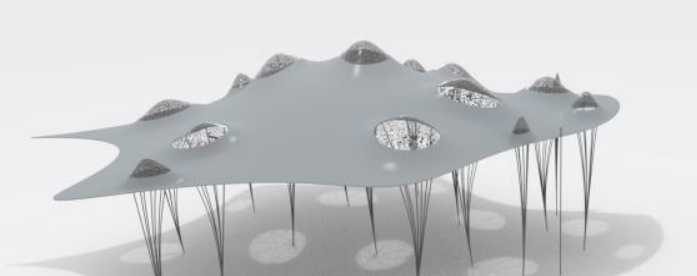
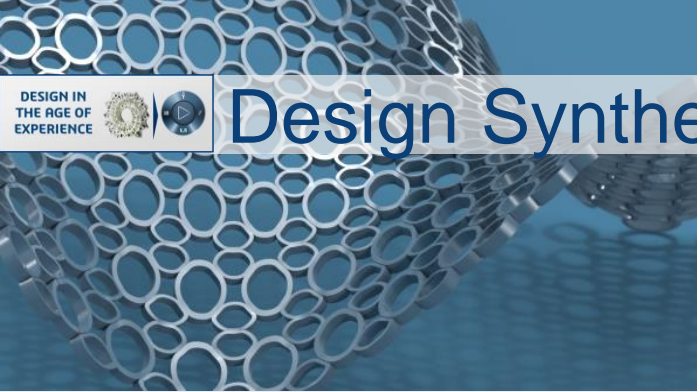



Design Synthesis | Evolution

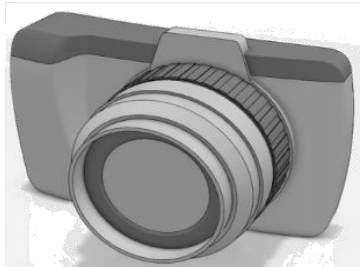

Direct Modeling

- Wireframe
- Surfaces
- Solid

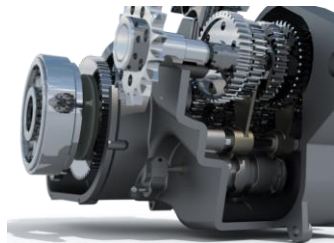

Spec-Driven

- Feature based
- Procedural
- Variational



Functional

- Functional Solvers
- Collaboration

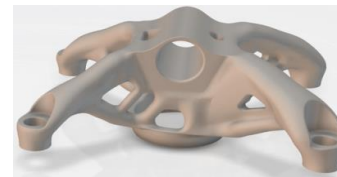

Experiential

- Biomimicry (Evolutionary)
- Synthesis (multiphysics optimization)
- Experience enabling Smart products



CATIA 3DEXPERIENCE: the platform works for you



Design Synthesis | Generative Design

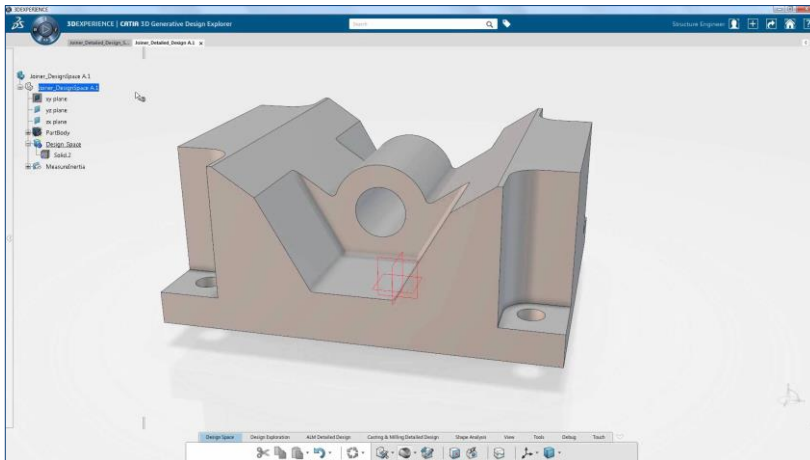

Benefits for Additive Manufacturing Ecosystem

- ▶ Guarantee the printability of parts and assemblies
- ▶ Improve the productivity
- ▶ High quality and precision shapes
- ▶ Ensure the Materials and Machines usage in their optimal range

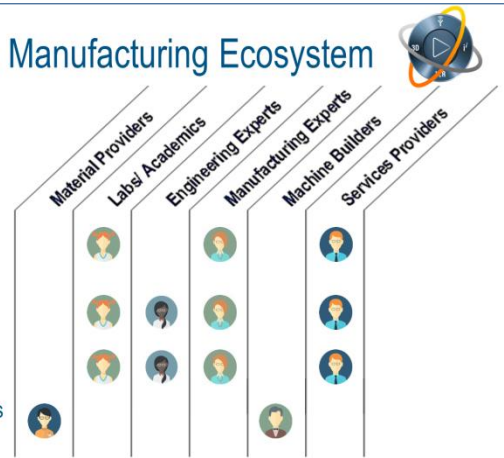



Automation | Automated Gear Box Design



Powertrain Performance Parameters
Gearbox architecture
Packaging Constraints

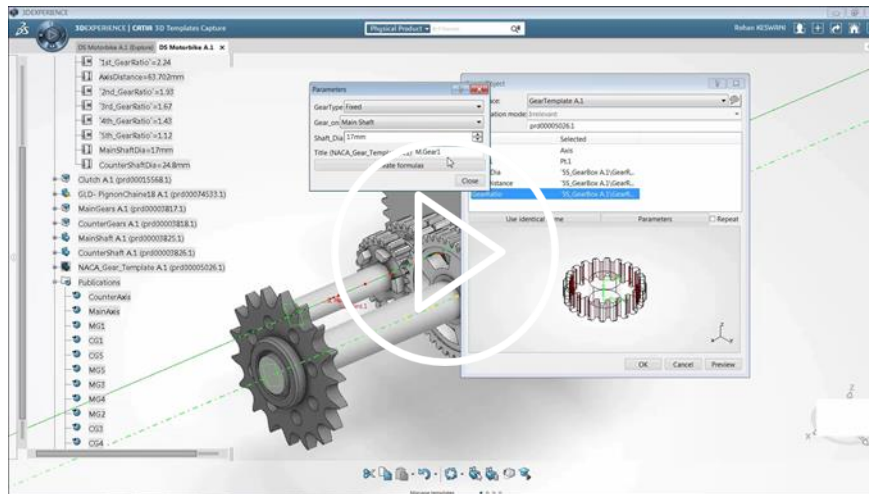

Detailed design including Verification / Certification Drawing & 3D Master

Engineering Knowledge
Manufacturing Knowledge



Design is Business

CATIA

3DEXPERIENCE®

Innovation + Business

=

Success



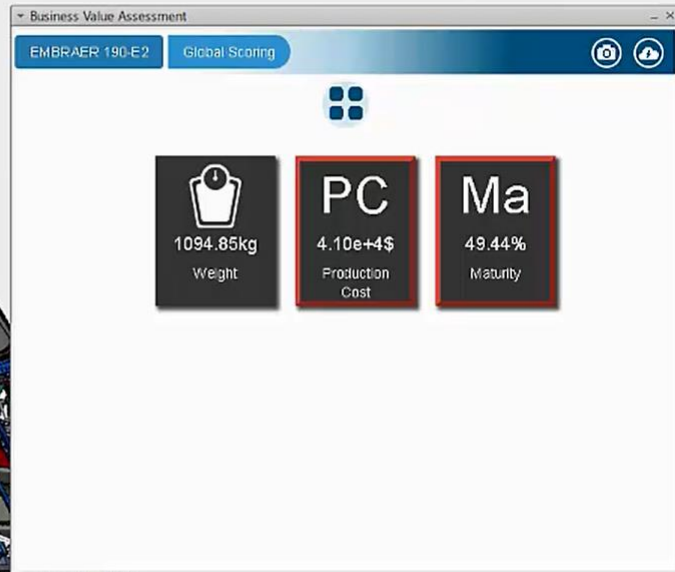
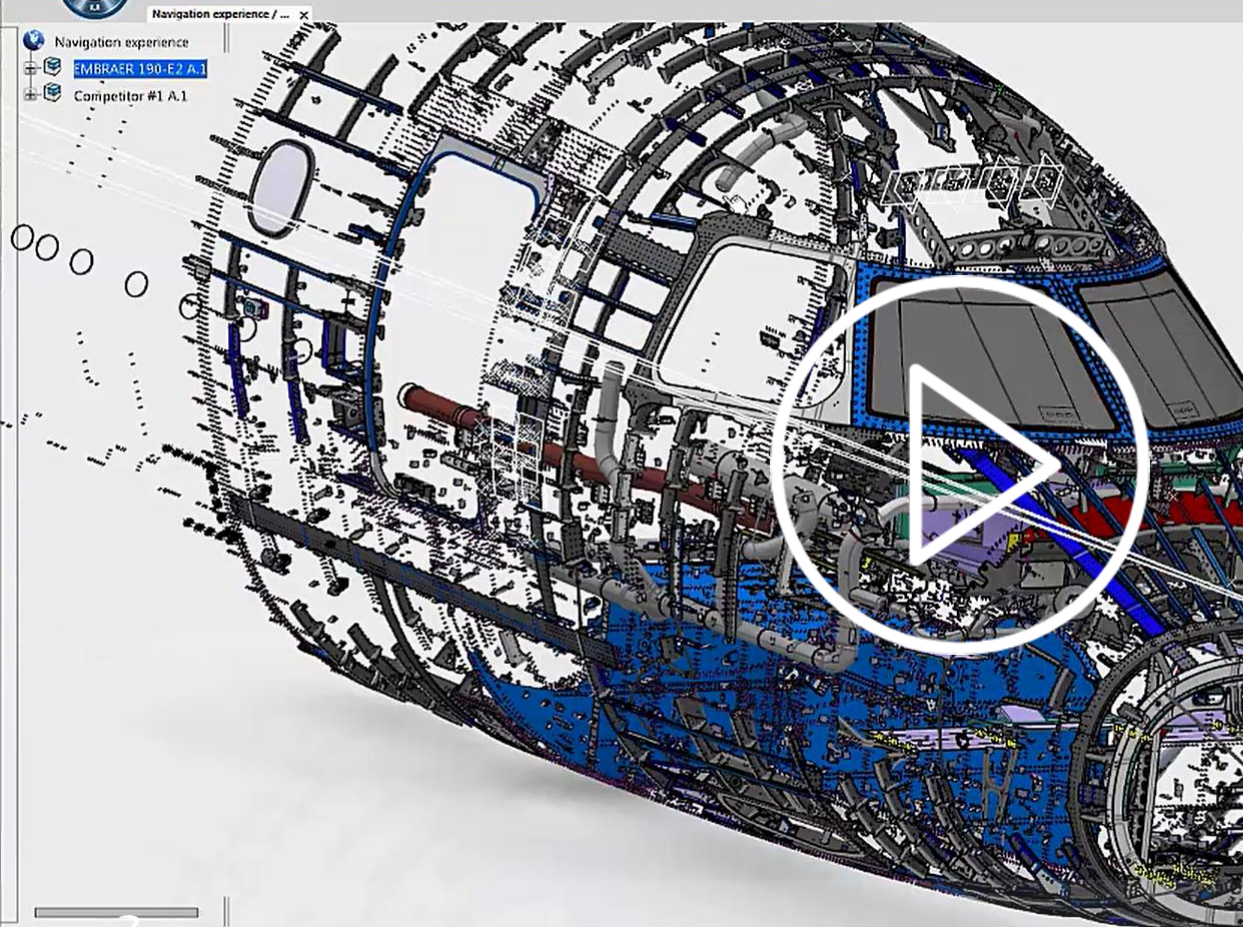

CATIA 3DEXPERIENCE

SOCIAL
DESIGN

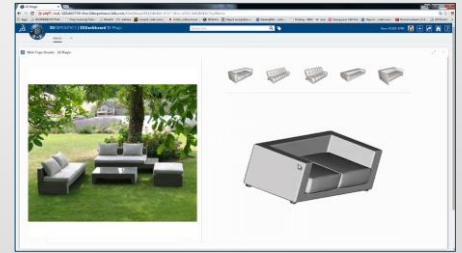



Anywhere, Anytime, Any Device

Start Somewhere, Progress Anywhere

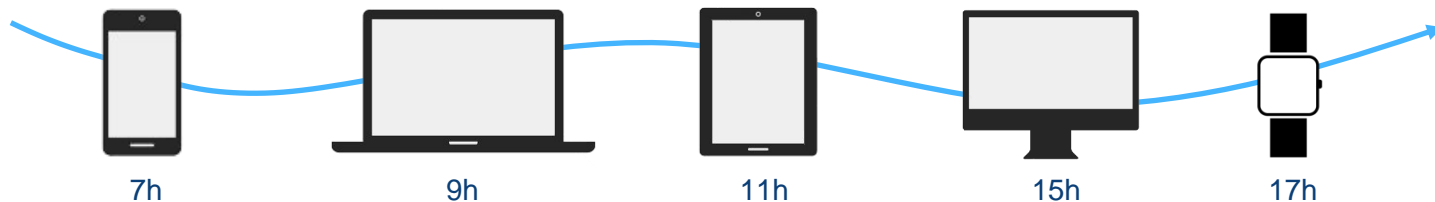

Simultaneous Usage (Secondary Screen)

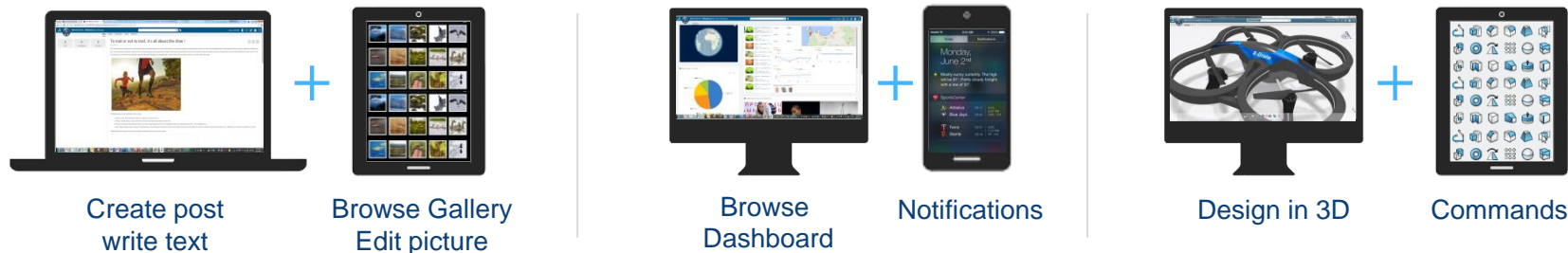



CATIA 3DEXPERIENCE

INDUSTRY
DIVERSIFICATION



M&O



AEC



EPU



CATIA 3DEXPERIENCE Roles Portfolio Role # New in R2016x

MULTI-INDUSTRY (51)

INDUSTRY SPECIFIC (23)

DESIGN (10)



ENGINEERING (51)

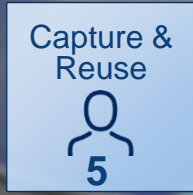
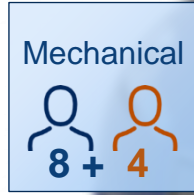

SYSTEMS (18)

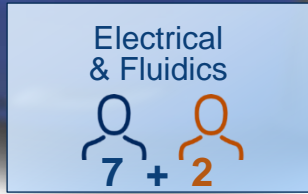
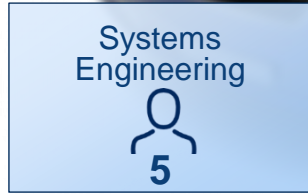

74 Roles out of which **20% New**
60 Roles available on the cloud

ZAHNER®



3D CATIA

3D DASSAULT SYSTEMES | The **3DEXPERIENCE®** Company

ARCHITECTURE

ENGINEERING

CONSTRUCTION

▶ Collaborate seamlessly with all stakeholders

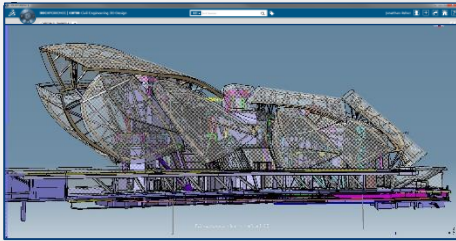

- ▶ Design in the context of the city
- ▶ Model & Manage sophisticated Geometry
- ▶ Manage Portfolio of Projects & resources

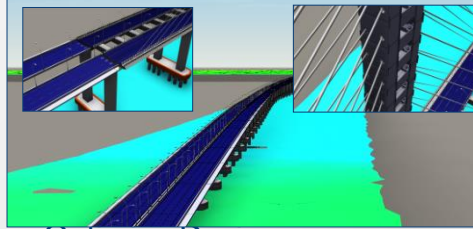

- ▶ Optimize Design for construction
- ▶ Model with exacting precision
- ▶ Capture & reuse | Create templates for engineering automation

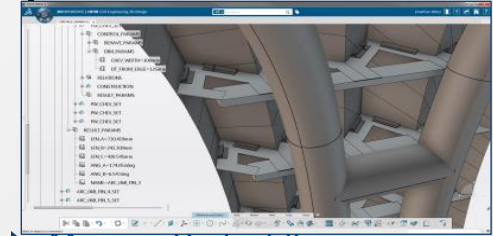

- ▶ Manage Budget & Schedule Constraints
- ▶ Create integrated models for construction coordination
- ▶ Capture & reuse | Create templates for fabrication automation

Footprint

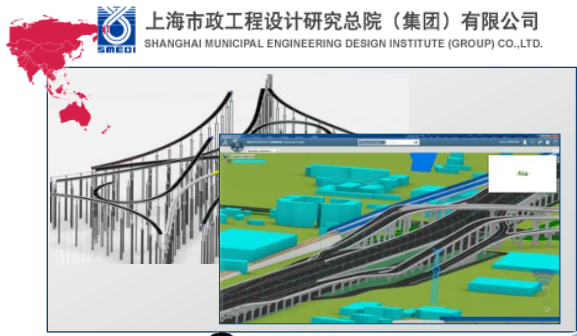

上海市政工程设计研究总院（集团）有限公司
SHANGHAI MUNICIPAL ENGINEERING DESIGN INSTITUTE (GROUP) CO.,LTD.



ZAHNER®



Kengo Kuma & Associates



CadMakers
Virtual Construction

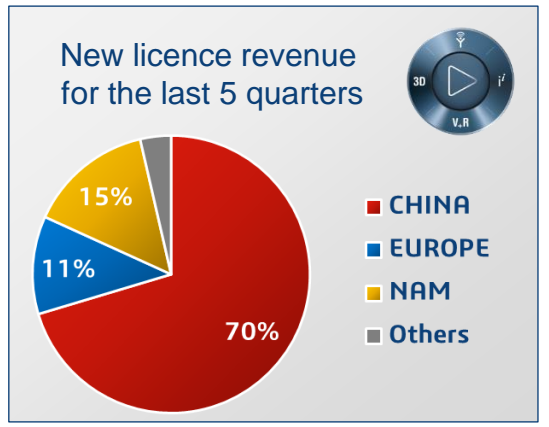

3DS.COM/CATIA © Dassault Systèmes | Confidential Information | 6/9/2016



INDUSTRY CHALLENGES



One single source
of truth for ecosystem
Scalability management
Capture & reuse designs
for sister ships

INSTANT BENEFITS

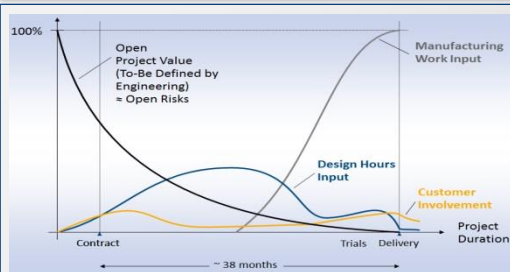

All decisions being
taken during
the first 6-8 weeks

SOPHISTICATION

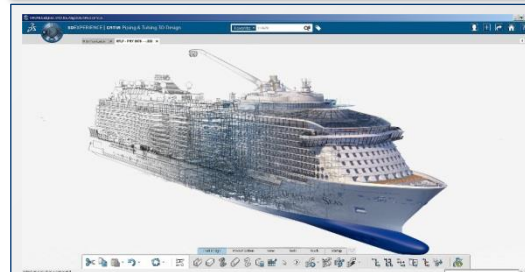

Example: cruise ship
Total # of components | 10M
Sensors | 30k
Rooms | 160 km²
Lightings | 40k
Piping | 200 km
Cables | 2K km



Key Wins 2015

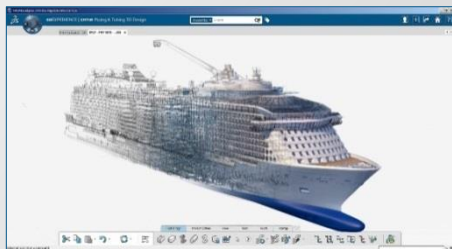

New licence revenue
for the last 5 quarters

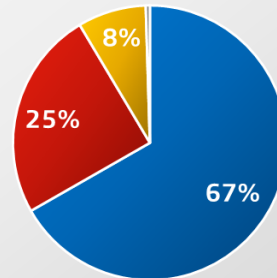

- EMEAR
- CHINA
- NAM
- Others

Snapshot

Leveraging

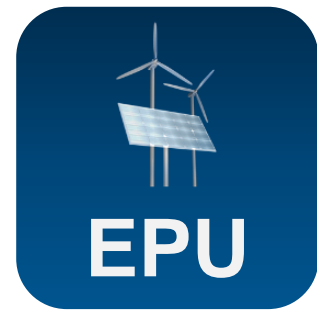
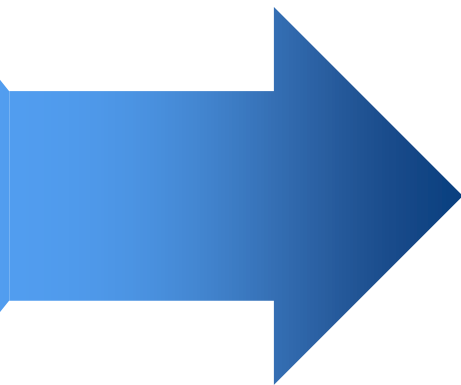

3DS.COM/CATIA © Dassault Systèmes | Confidential Information | 6/9/2016

CATIA 3DEXPERIENCE

INTERNET OF
EXPERIENCES





Evaluate System behavior

Experience system virtually on a digital scenario

Internet Of Experiences | How ?

Create and 3D experiment multi-physics multi-scale systems
“facilitating decision-making at conceptual stage, eliminating physical prototypes”

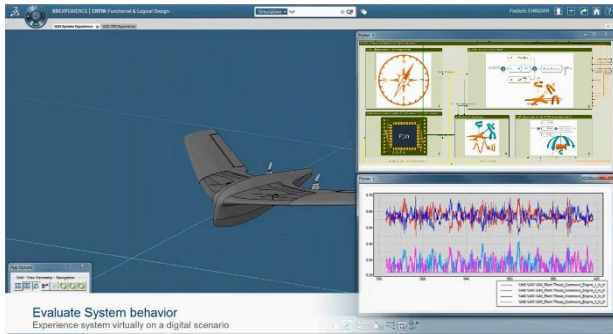

System Ideation



Virtual Validation



Usage Experiences

Connecting Drones, Devices & Environment to deliver new Experiences

T&M **Connected Drone**



Aircraft OEM*



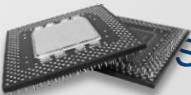

Gimbal Camera Aircraft Suppliers



Semiconductors

EPU **Smart Environment**

HT **Connected Devices**



Mission Control



Computing & Telecom.



Semiconductors

*Original Equipment Manufacturer

3DS.COM/CATIA © Dassault Systèmes | Confidential Information | 6/9/2016

Internet Of Experiences | Footprint

PSA Peugeot Citroen

PSA PEUGEOT CITROËN 



Using the global System Engineering portfolio:
System Architecture
Embedded Electronic Architecture



V5 V5-6 V6-5 **3DEXP. R2013x**

Smart, Safe & Connected
Systems Definition & Performance
Validation

Acquisition Modelon GmbH



Reinforcement of CATIA portfolio with
“ready-to-experience” content for
systems
modeling & simulation.

Powertrain Experience
Battery & Electrical



ALSTOM



CATIA | eCARS Market

Wins references



16-Q1 Wins



Opportunities

New players
Last example:

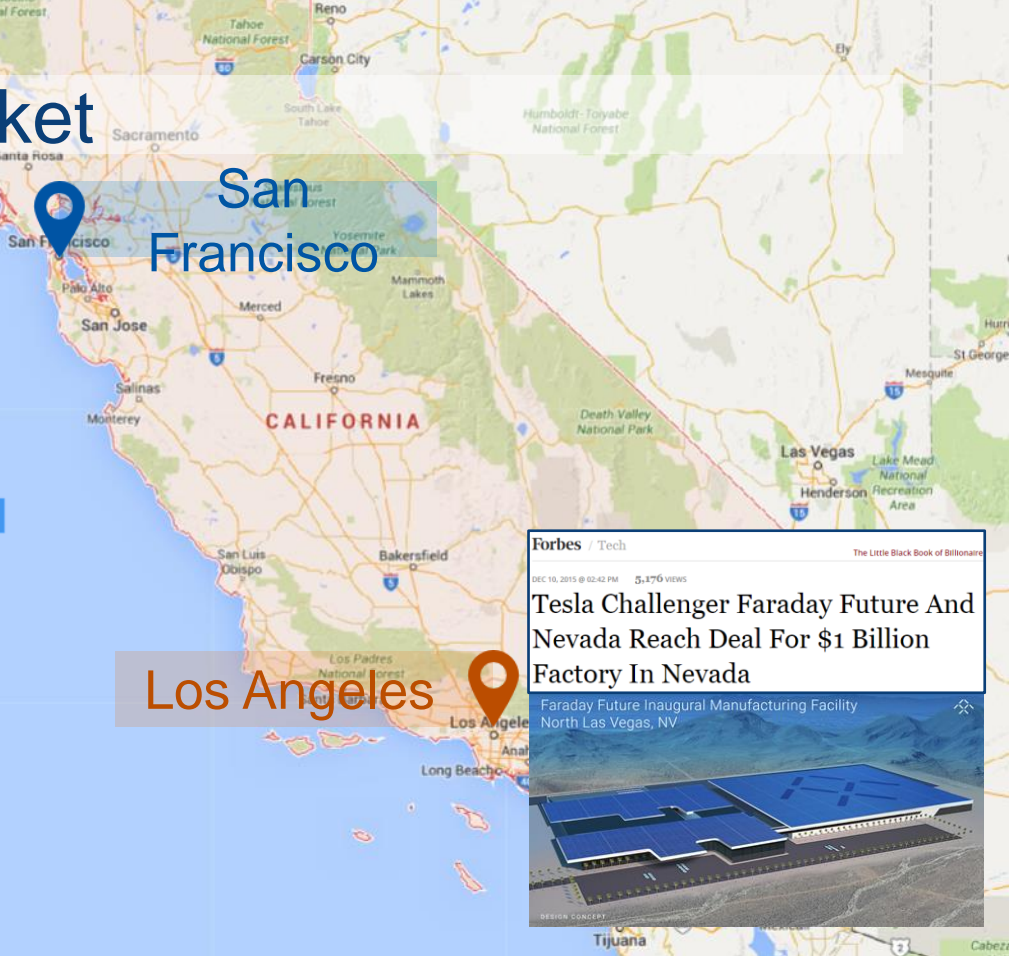
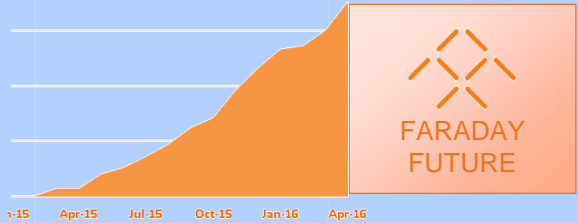

Forbes / Tech The Little Black Book of Billionaires

DEC 10, 2015 @ 02:42 PM 5,176 VIEWS

Tesla Challenger Faraday Future And Nevada Reach Deal For \$1 Billion Factory In Nevada

Faraday Future Inaugural Manufacturing Facility North Las Vegas, NV

REGION CONCEPT

Growth Drivers for CATIA

DESIGN IN
THE AGE OF
EXPERIENCE

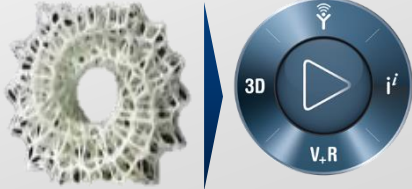

INDUSTRY
DIVERSIFICATION



INTERNET
OF
EXPERIENCE



SOCIAL
DESIGN

